

Felix

SITS



Felix

UPHOLSTERY

COMFORTS

COVERS



fabric



STD standard



FC fixed

All drawings shown height with leg no. 111E H-15.
Two mattresses available: bonell and foam.

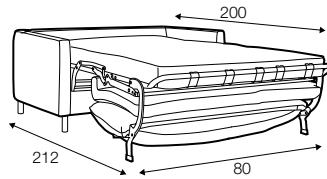
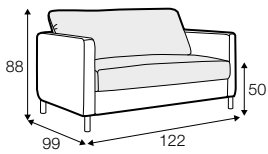

armchair sofa bed

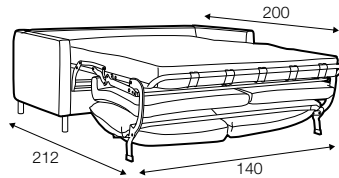
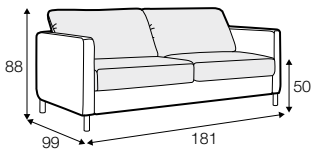

3 seater sofa bed

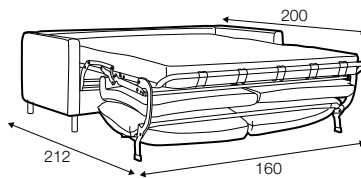
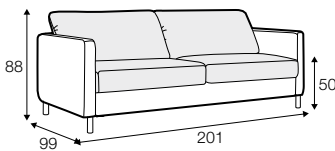

4 seater sofa bed

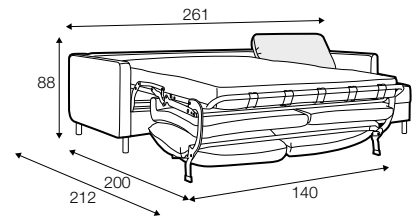
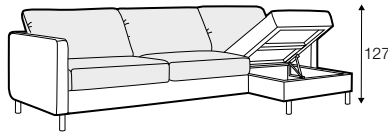
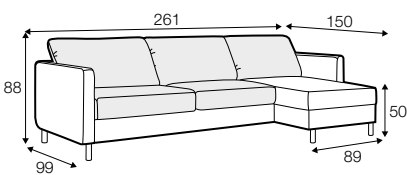

set 1 right / or left

3 seater sofa bed left / or right + chaiselongue box right / or left

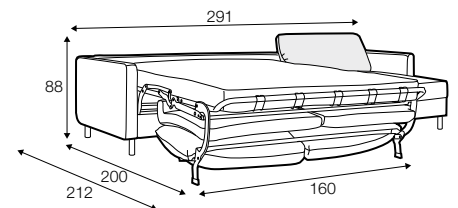
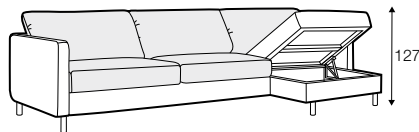
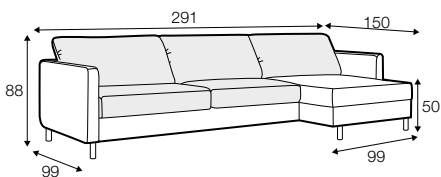

set 2 right / or left

4 seater sofa bed left / or right + chaiselongue box right / or left

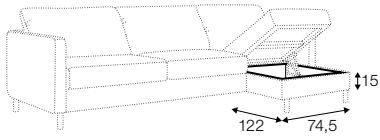

box dimensions
set 1

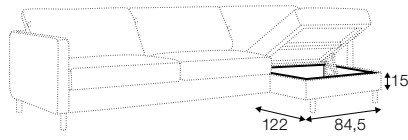

box dimensions
set 2

extra dimensions

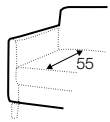

depth of seat

accessories

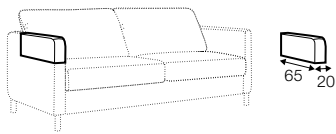

armrest protection

legs

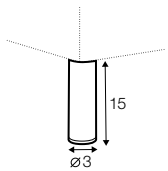

no. 111E
metal chrome,
painted black or grey
and brushed steel*

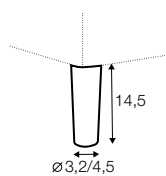

no. 153A
wood

profile

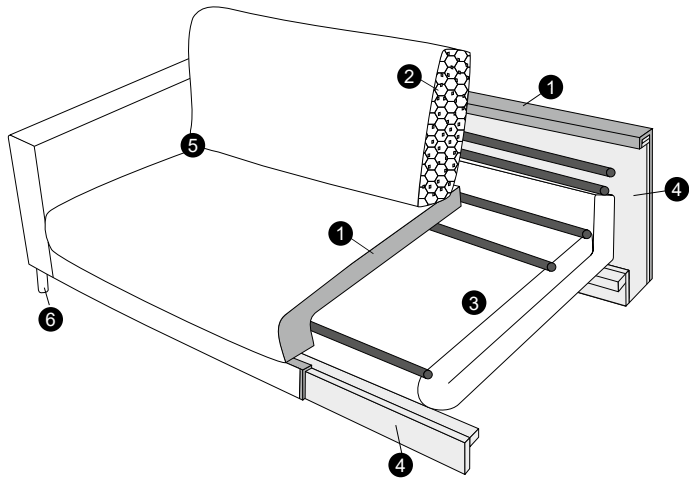

standard

1. polyurethane foam / high resilient polyurethane foam
2. foam flakes with silicone balls
3. bonell / foam mattress
4. solid wood and wood based elements
5. fabric
6. solid wood / metal legs