

Jenny

SITS



Jenny

J. Archer

designed by: Ian Archer



UPHOLSTERY COMFORTS COVERS SPECIAL



fabric



STD standard



FC fixed



modular system

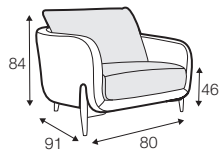

armchair

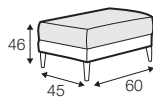

footstool 60x45

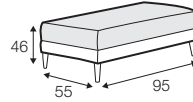

footstool 95x55

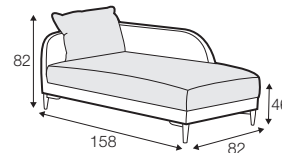

chaiselongue
freestanding left

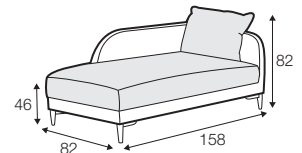

chaiselongue
freestanding right

version A

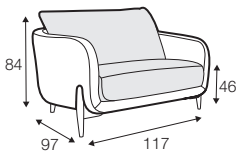

armchair wide

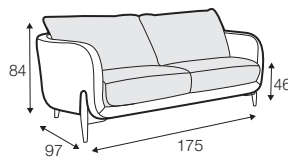

2 seater

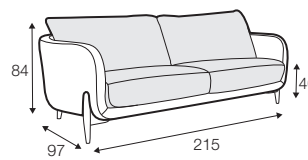

3 seater

version C

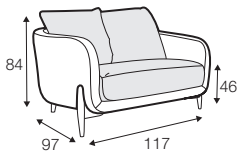

armchair wide

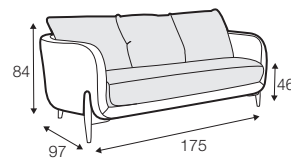

2 seater

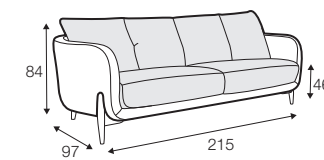

3 seater

example of sets with back cushions combinations

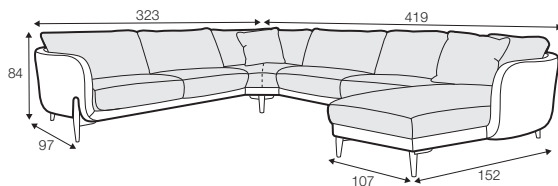

example 1

3 seater ver. A left / or right
+ corner 90° round ver. C
+ 3 seater without armrests ver. A
+ chaiselongue wide ver. C right / or left

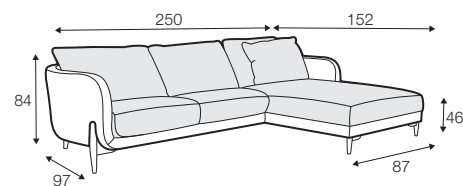

example 2

2 seater ver. A left / or right
+ chaiselongue ver. C right / or left

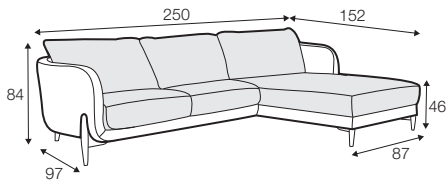

set 1 ver. A right (or left)
 2 seater ver. A left / or right
 + chaiselongue ver. A right / or left

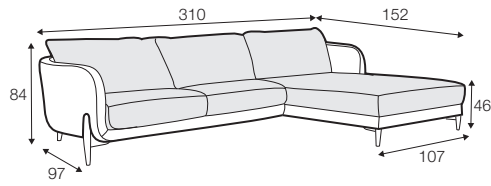

set 2 ver. A right (or left)
 3 seater ver. A left / or right
 + chaiselongue wide ver. A right / or left

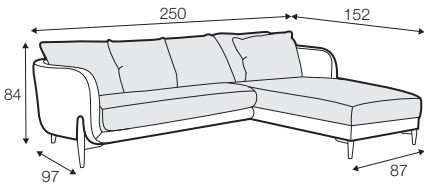

set 1 ver. C right (or left)
 2 seater ver. C left / or right
 + chaiselongue ver. C right / or left

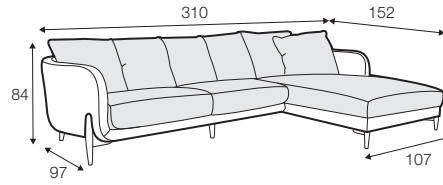

set 2 ver. C right (or left)
 3 seater ver. C left / or right
 + chaiselongue wide ver. C right / or left

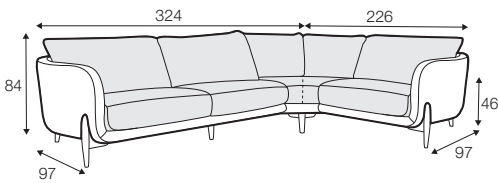

set 5 ver. A right (or left)
 3 seater ver. A left / or right
 + corner 90 round ver. A
 + armchair wide ver. A right / or left

modular system

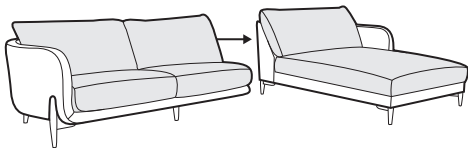

elements of the modular system version A

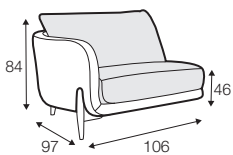

armchair wide
 left / or right

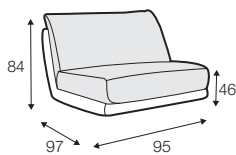

armchair wide
 without armrests

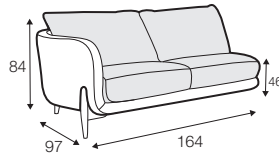

2 seater left / or right

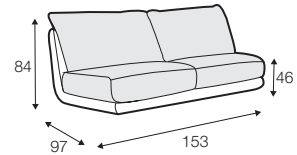

2 seater
 without armrests

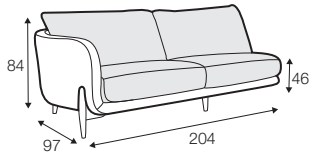

3 seater left / or right

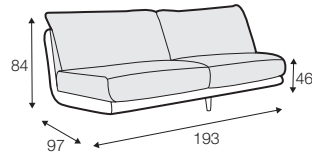

3 seater without armrests

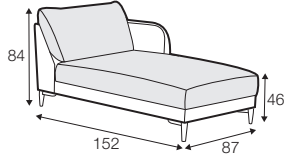

chaiselongue right / or left

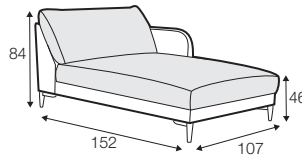

chaiselongue wide right / or left

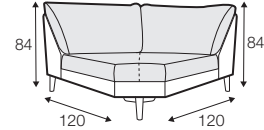

corner 90° round

elements of the modular system version C

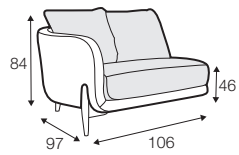

armchair wide
left / or right

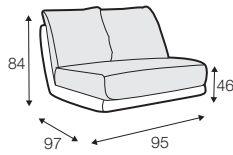

armchair wide
without armrests

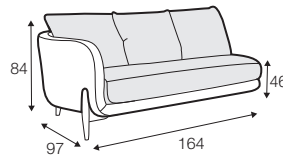

2 seater left / or right

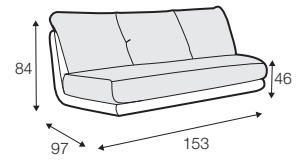

2 seater
without armrests

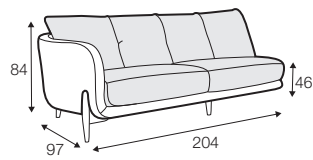

3 seater left / or right

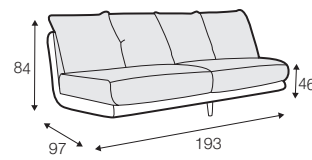

3 seater without armrests

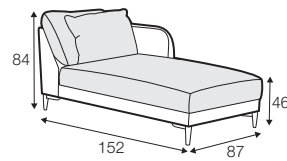

chaiselongue
right / or left

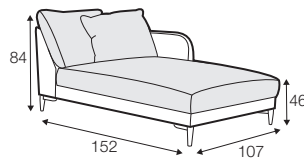

chaiselongue wide
right / or left

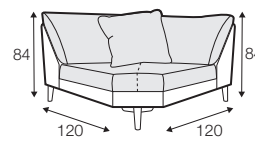

corner 90° round

extra dimensions

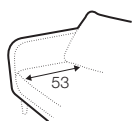

depth of
armchair seat

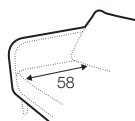

depth of
sofa seat

accessories

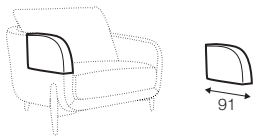

armrest protection
armchair

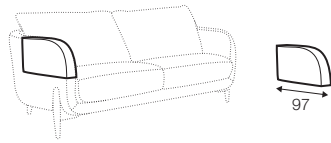

armrest protection
armchair wide, 2 seater, 3 seater

legs

The width of the sofas depends on the legs. The difference is 5 cm overall dimensions.

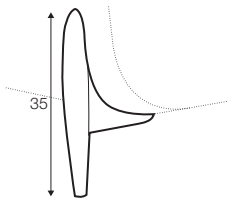

no. 159
wood
front

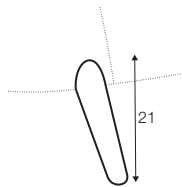

no. 159A
wood
back

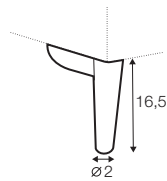

no. 159B
wood
only chaiselongue

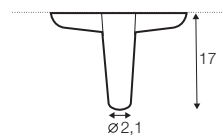

no. 159C
wood
only corner

profile

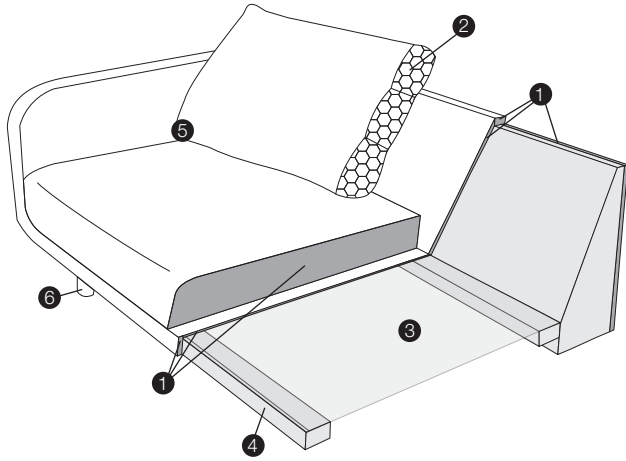

standard

1. polyurethane foam/high resilient polyurethane foam
2. silicone balls
3. dynaflex - elastic fabric
4. solid wood and wood based elements
5. fabric
6. solid wood legs