

# Jenny

# SITS



# Jenny

UPHOLSTERY COMFORTS COVERS SPECIAL



fabric



STD standard



FC fixed



modular system

All drawings shown height with leg no. 159.

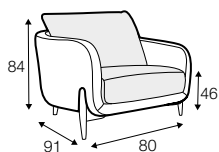

armchair

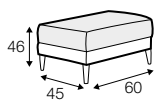

footstool 60x45

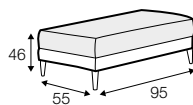

footstool 95x55

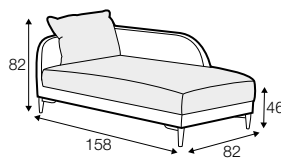

chaiselongue freestanding  
left / or right

## version A

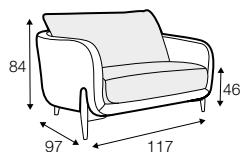

armchair wide

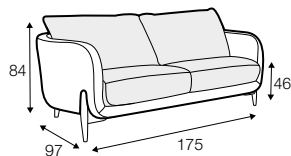

2 seater

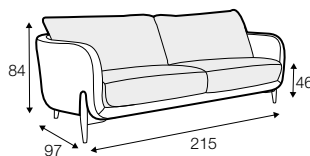

3 seater

## version C

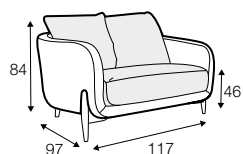

armchair wide

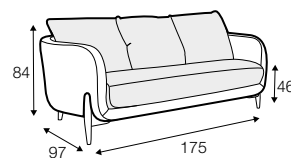

2 seater

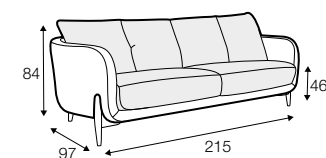

3 seater

## example of sets with back cushions combinations

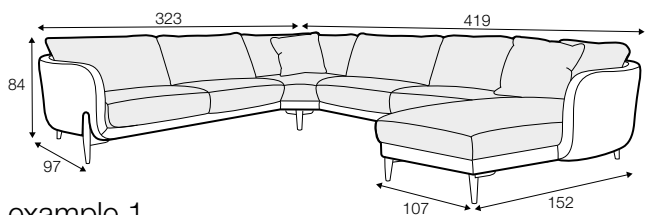

example 1

3 seater ver. A left / or right  
+ corner 90° round ver. C  
+ 3 seater without armrests ver. A  
+ chaiselongue wide ver. C right / or left

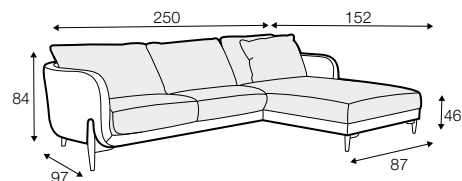

example 2

2 seater ver. A left / or right  
+ chaiselongue ver. C right / or left

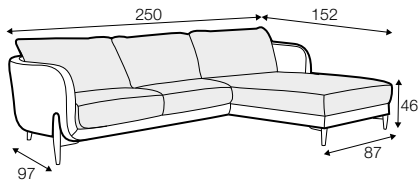

set 1 ver. A right (or left)  
2 seater ver. A left / or right  
+ chaiselongue ver. A right / or left

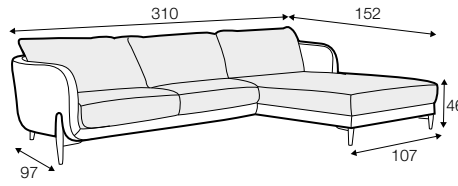

set 2 ver. A right (or left)  
3 seater ver. A left / or right  
+ chaiselongue wide ver. A right / or left

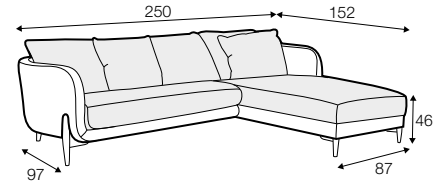

set 1 ver. C right (or left)  
2 seater ver. C left / or right  
+ chaiselongue ver. C right / or left

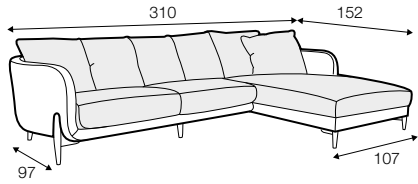

set 2 ver. C right (or left)  
3 seater ver. C left / or right  
+ chaiselongue wide ver. C right / or left

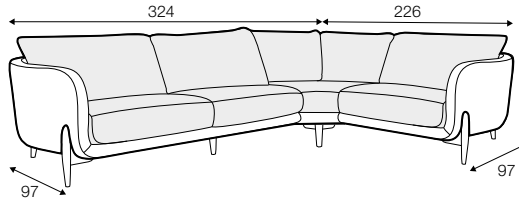

set 5 ver. A right (or left)  
3 seater ver. A left / or right  
+ corner 90 round ver. A  
+ armchair wide ver. A right / or left

## modular system

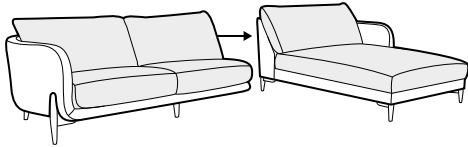

## elements of the modular system version A

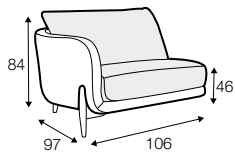

armchair wide  
left / or right

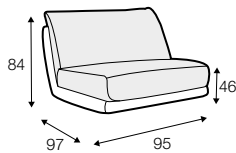

armchair wide  
without armrests

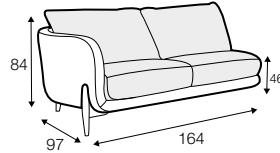

2 seater left / or right

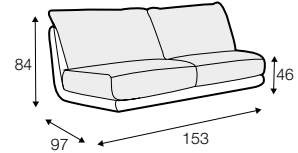

2 seater  
without armrests

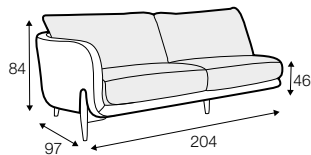

3 seater left / or right

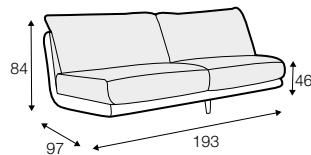

3 seater without armrests

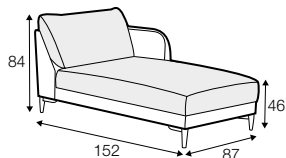

chaiselongue right / or left

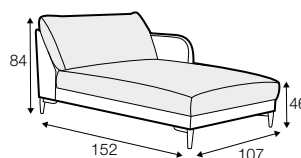

chaiselongue wide right / or left

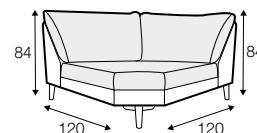

corner 90° round

## elements of the modular system version C

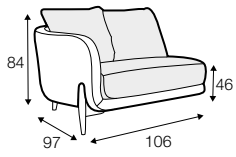

armchair wide  
left / or right

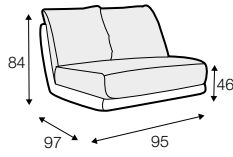

armchair wide  
without armrests

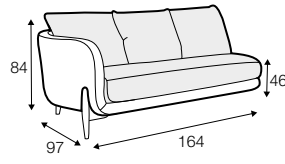

2 seater left / or right

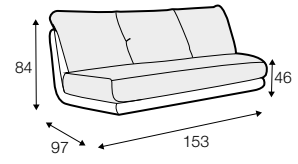

2 seater  
without armrests

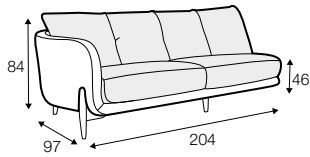

3 seater left / or right

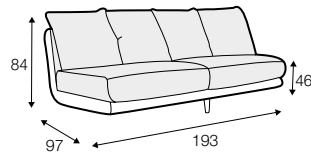

3 seater without armrests

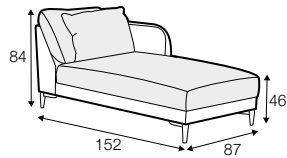

chaiselongue  
right / or left

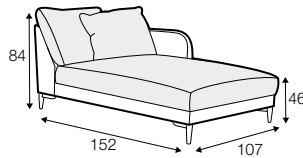

chaiselongue wide  
right / or left

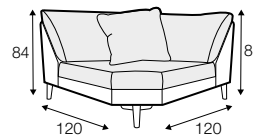

corner 90° round

## extra dimensions

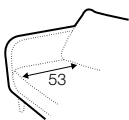

depth of  
armchair seat

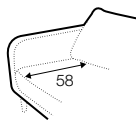

depth of  
sofa seat

## legs

The width of the sofas depends on the legs. The difference is 5 cm overall dimensions.

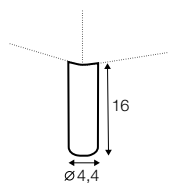

no. 158  
wood  
front

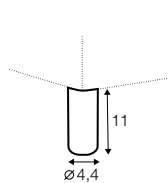

no. 158A  
wood  
back

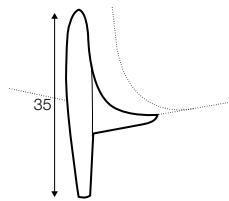

no. 159  
wood  
front

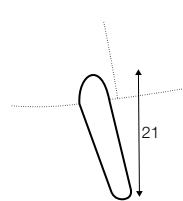

no. 159A  
wood  
back

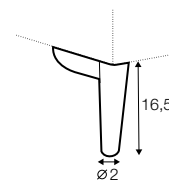

no. 159B  
wood  
only chaiselongue

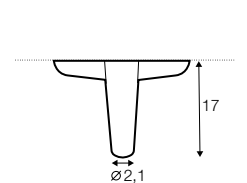

no. 159C  
wood  
only corner

## profile

---

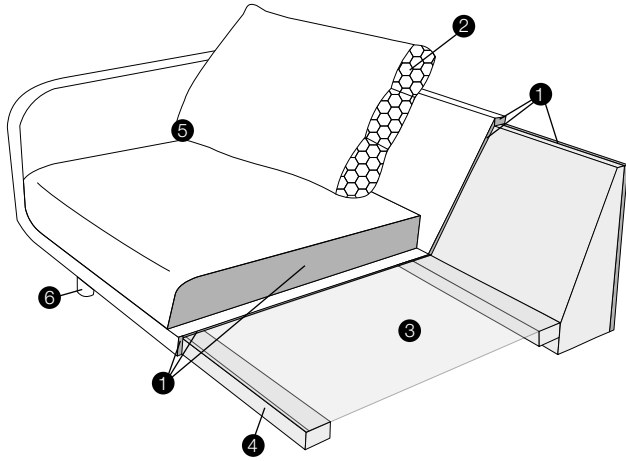

### standard

1. polyurethane foam/high resilient polyurethane foam
2. silicone balls
3. dynaflex - elastic fabric
4. FSC® certified solid wood and wood based elements
5. fabric
6. FSC® certified solid wood legs