

# Teddy

SITS



# Teddy

designed by: Steven Schilte



## UPHOLSTERY



fabric

## COMFORTS



STD standard



LUX lux



CLS classic

## COVERS



FC fixed

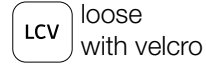

LCV loose with velcro

## SPECIAL



modular system

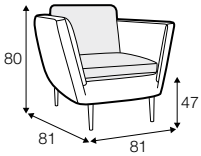

armchair

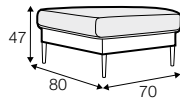

footstool 80x70

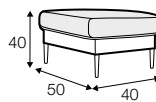

footstool 50x40  
only for armchair

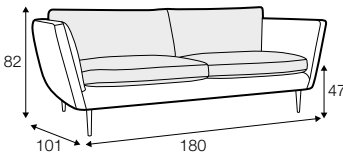

2 seater

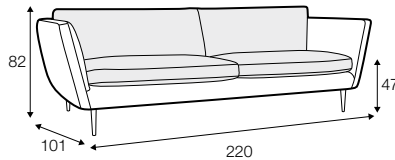

3 seater

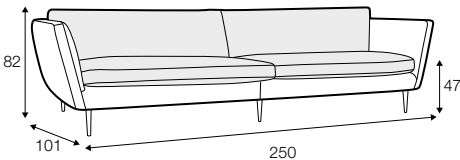

4 seater divided with two cushions

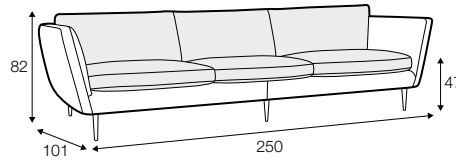

4 seater divided with three cushions

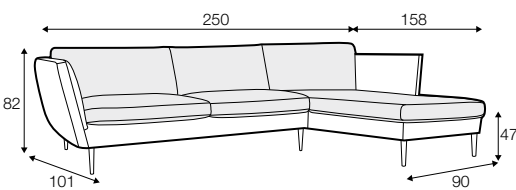

set 1 right / or left

2 seater left / or right + chaiselongue right / or left

set 2 right / or left

3 seater left / or right + chaiselongue wide right / or left

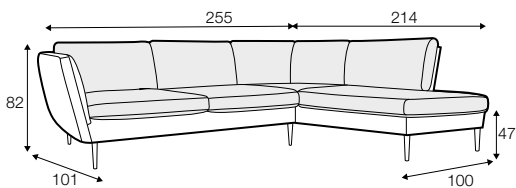

set 3 right / or left

2 seater left / or right + divan right / or left

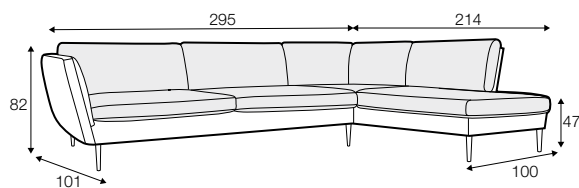

set 4 right / or left

3 seater left / or right + divan right / or left

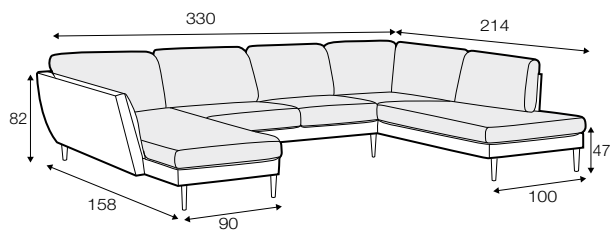

set 5 right / or left  
chaiselongue left / or right + 2 seater without armrests  
+ divan right/or left

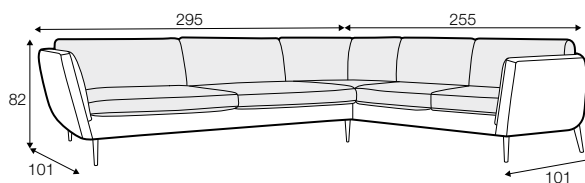

set 6 right / or left  
3 seater left / or right + corner 90° + 2 seater right / or left

### elements of the modular system

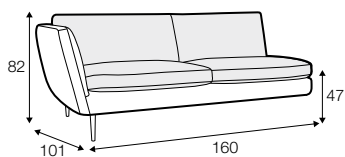

2 seater left / or right

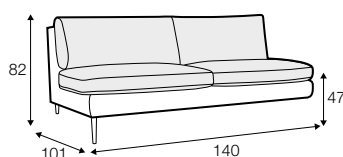

2 seater without armrests

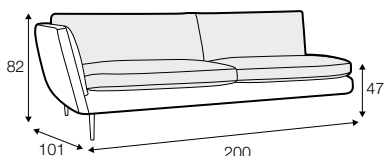

3 seater left / or right

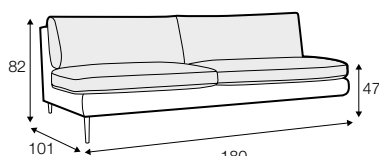

3 seater without armrests

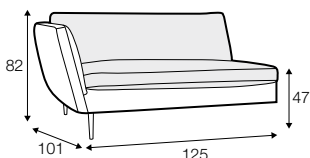

element 125 left / or right

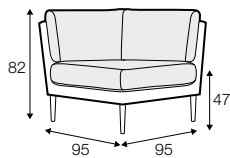

corner 90°

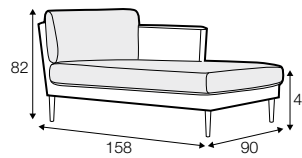

chaiselongue right / or left

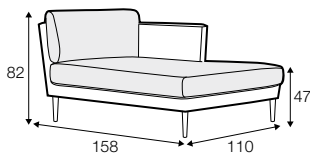

chaiselongue wide right / or left

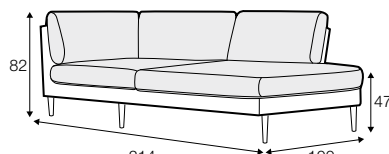

divan right / or left

### extra dimensions

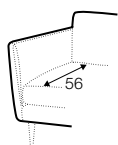

depth of sofas

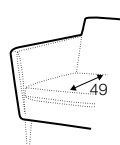

depth of armchair

## accessories

---

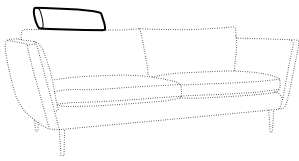

headrest L-62

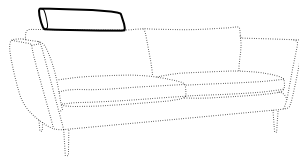
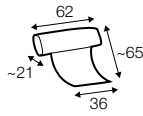

headrest L-77

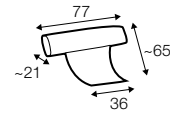

endpart left / or right

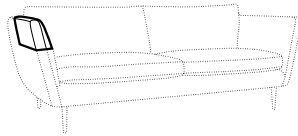
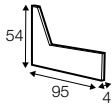

armrest protection

## legs

---

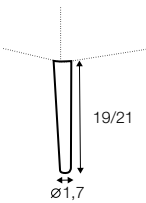

no. 186  
wood

sofas H-19  
footstool for armchair H-19  
armchair: front H-21 back H-19  
corner, divan: H-19

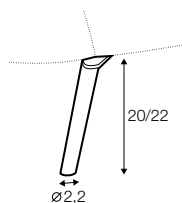

no. 160  
metal chrome,  
painted black

sofas H-20  
footstool for armchair H-20  
armchair: front H-22 back H-20  
divan: front H-20 back 160A H-20  
corner 160A H-20

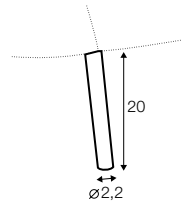

no. 160C  
metal chrome,  
painted black

only for divan,  
corner

## profile

---

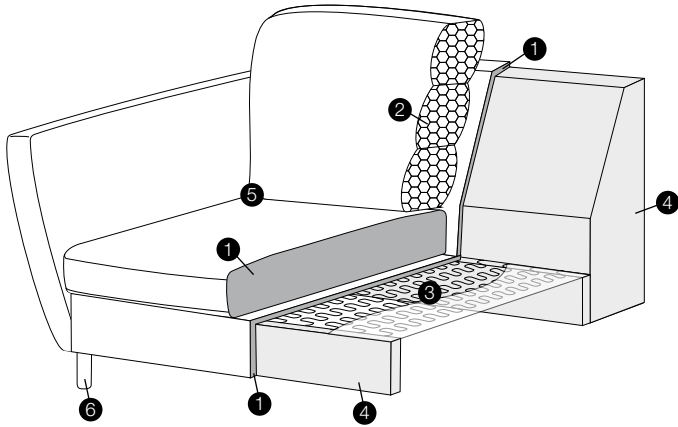

### standard

1. polyurethane foam / high resilient polyurethane foam
2. silicone balls
3. springs
4. solid wood and wood based elements
5. fabric
6. solid wood or metal legs

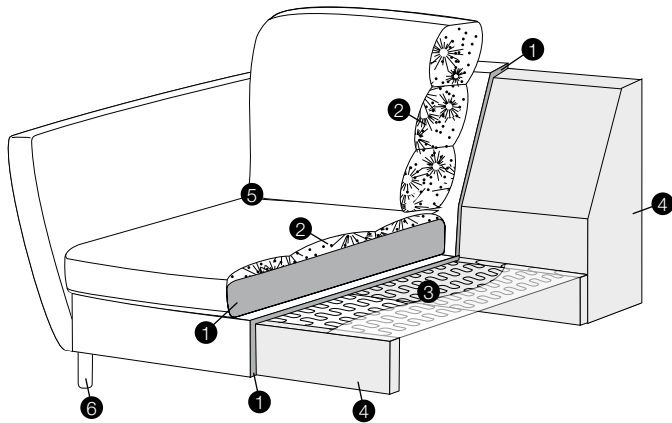

### lux

1. polyurethane foam / high resilient polyurethane foam
2. cushion chamber with mix of feather and silicone balls
3. springs
4. solid wood and wood based elements
5. fabric
6. solid wood or metal legs

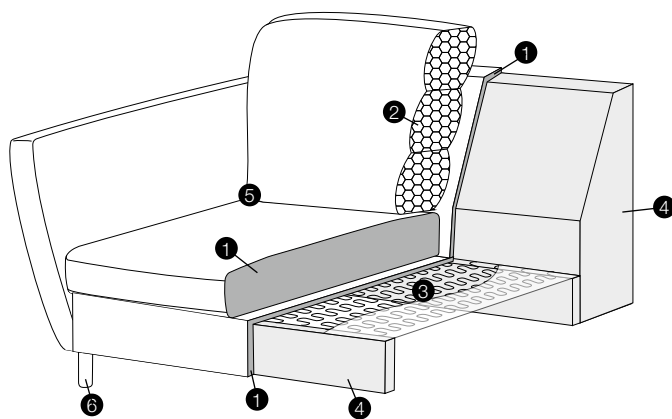

### classic

1. polyurethane foam / high resilient polyurethane foam
2. silicone balls
3. springs
4. solid wood and wood based elements
5. fabric
6. solid wood or metal legs