

Julia

SITS



Julia

auter

designed by: Dan Ihreborn



UPHOLSTERY



fabric

COMFORTS

LUX lux

CLS classic

COVERS

LCV loose with velcro

LC loose

SPECIAL



modular system

Armchair with detail available only in loose cover.

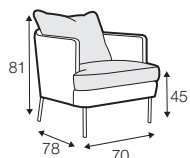

armchair



armchair in loose cover

To achieve best results we recommend to choose thin natural fabrics.

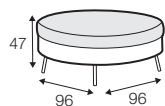

footstool ø96

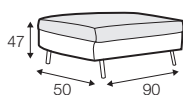

footstool 90x50

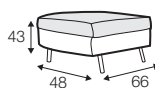

footstool 66x48
only for armchair

elements with small back cushions

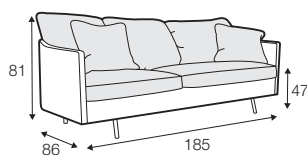

2 seater

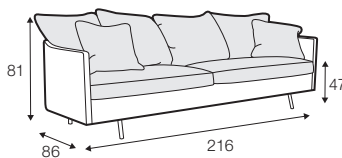

3 seater

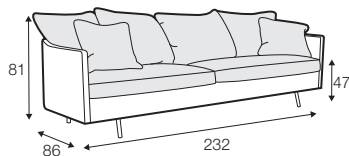

3XL seater

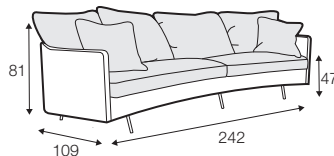

3XL seater round divided

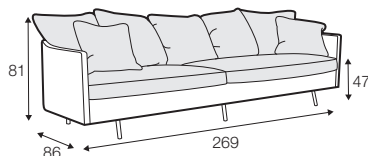

4 seater straight divided

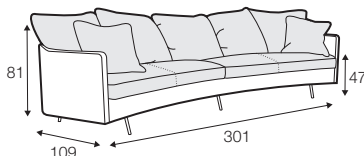

4 seater round divided

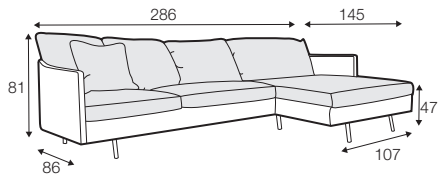

set 2 right / or left
2 seater left / or right + chaiselongue wide right / or left

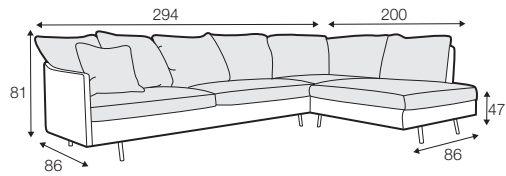

set 3 right / or left
3 seater left / or right + divan right / or left

elements with big back cushions

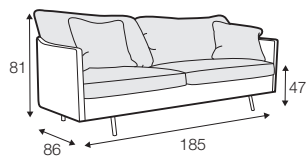

2 seater

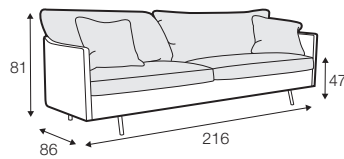

3 seater

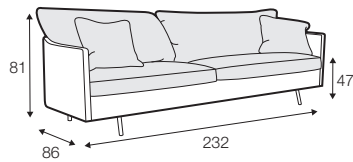

3XL seater

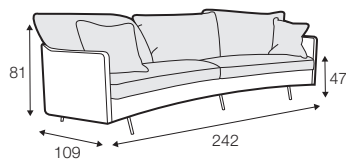

3XL seater round divided

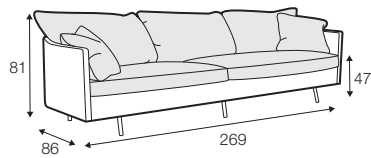

4 seater straight divided

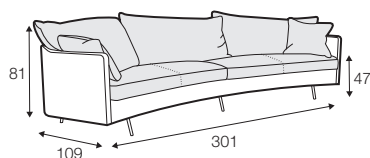

4 seater round divided

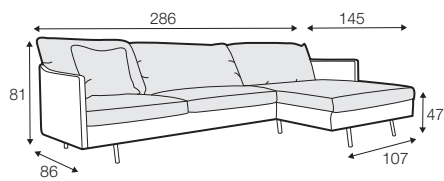

set 2 right / or left
2 seater left / or right + chaiselongue wide right / or left

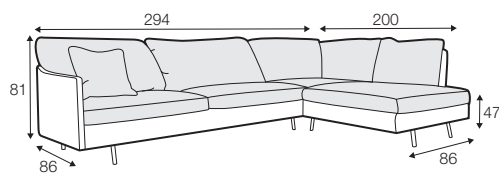

set 3 right / or left
3 seater left / or right + divan right / or left

modular system

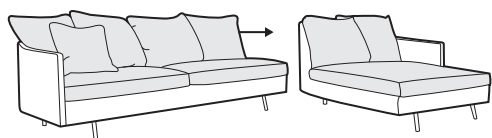

elements of the modular system
elements with small back cushions

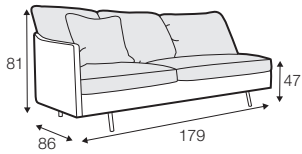

2 seater left / or right

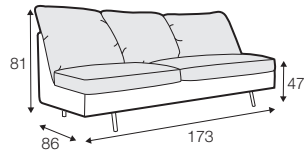

2 seater without armrests

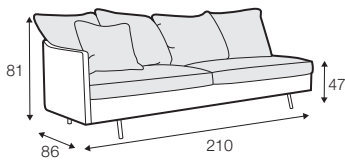

3 seater left / or right

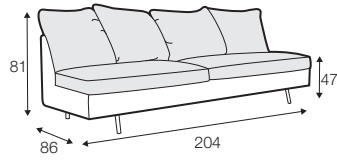

3 seater without armrests

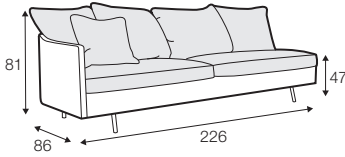

3XL seater left / or right

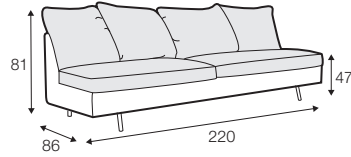

3XL seater without armrests

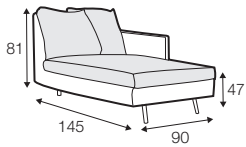

chaiselongue right / or left

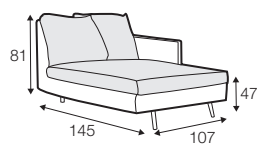

chaiselongue wide right / or left

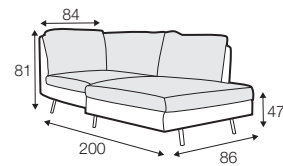

divan right / or left

elements of the modular system
elements with big back cushions

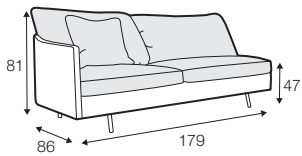

2 seater left / or right

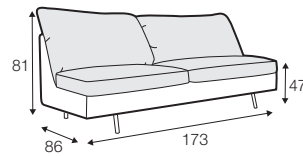

2 seater without armrests

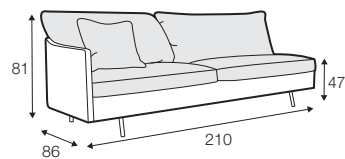

3 seater left / or right

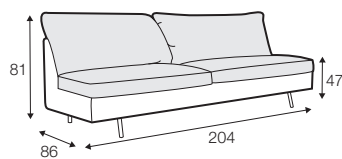

3 seater without armrests

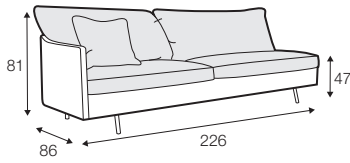

3XL seater left / or right

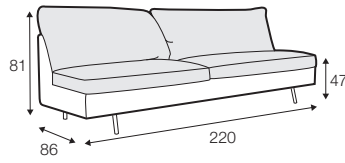

3XL seater without armrests

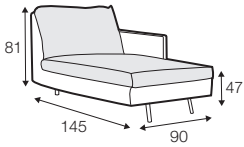

chaiselongue right / or left

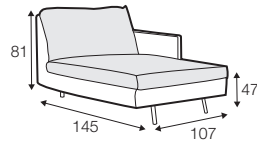

chaiselongue wide right / or left

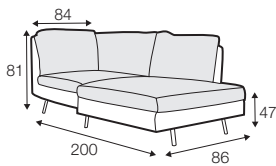

divan right / or left

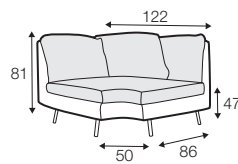

corner 90°

extra dimensions

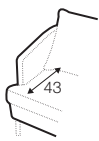

depth of
armchair seat

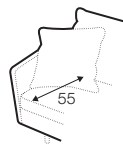

depth of
sofa seat

legs

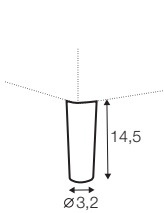

no. 153
wood
front
sofas, set 2, set 3,
footstool fi 96,
footstool 90x50, corner,
divan, chaiselongues

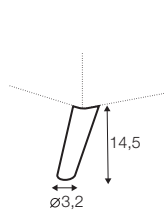

no. 141A
wood
back with front leg
no. 153
corner

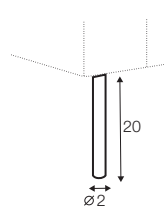

no. 149
metal chrome,
painted black
footstool 66x48

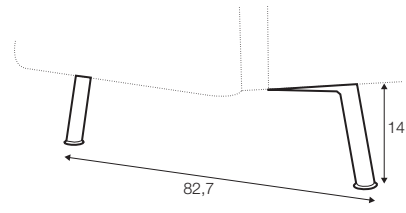

no. 150A
metal chrome,
painted black
sofas, set 2, set 3
corner: 150A front, 150D back

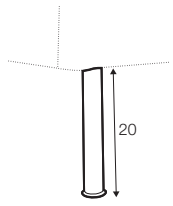

no. 150B
metal chrome,
painted black
armchair: 150B front,
150C back

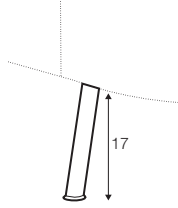

no. 150C
metal chrome,
painted black
armchair: 150B front,
150C back

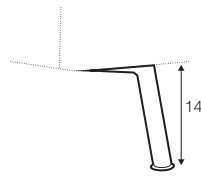

no. 150D
metal chrome,
painted black
footstool 96, footstool 90x50,
divan, chaiselongues

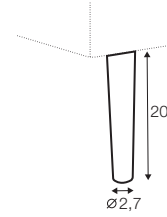

no. 154A
wood
footstool 66x48
armchair:
154A front,
154B back

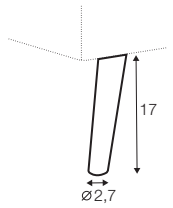

no. 154B
wood
armchair:
154A front,
154B back

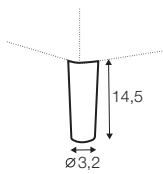

no. 154C
wood
4 seater:
153 front,
154C back

profile

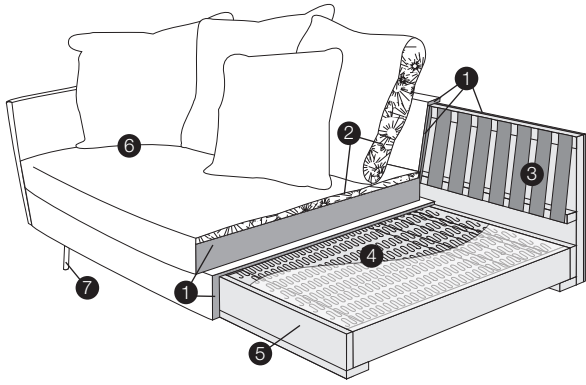

lux

1. polyurethane foam / high resilient polyurethane foam
2. cushion chamber with feather
3. upholstery belts
4. springs
5. solid wood and wood based elements
6. fabric
7. solid wood or metal legs

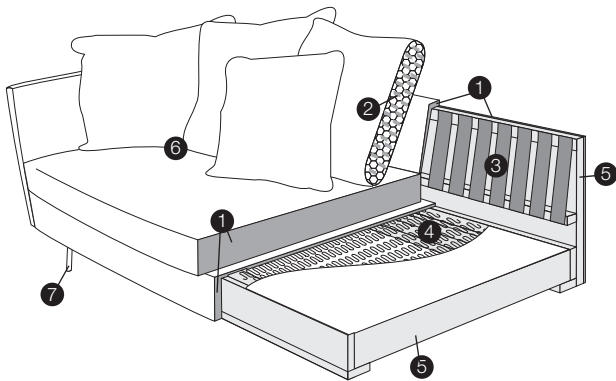

classic

1. polyurethane foam / high resilient polyurethane foam
2. foam flakes with silicone balls
3. upholstery belts
4. springs
5. solid wood and wood based elements
6. fabric
7. solid wood or metal legs