

Emma

SITS



# Emma

*I Archer*

designed by: Ian Archer



## UPHOLSTERY



fabric

## COMFORTS



standard



lux

## COVERS



fixed



loose with velcro

## SPECIAL



modular system

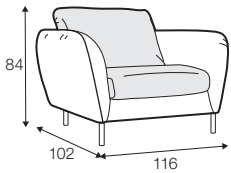

armchair

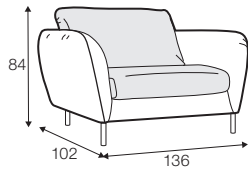

armchair wide

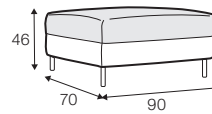

footstool 90x70

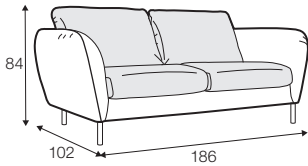

2 seater

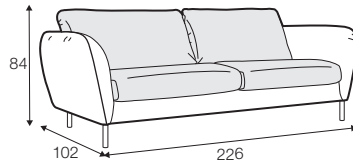

3 seater

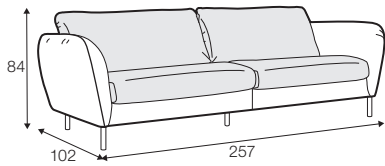

3XL seater divided

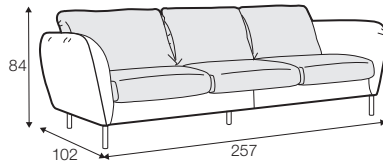

3XL seater divided with 3 cushions

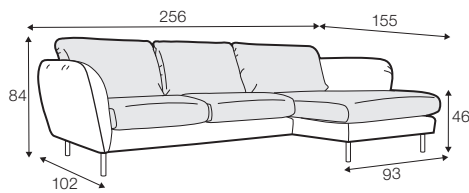

set 1 right / or left  
2 seater left / or right + chaiselongue right / or left

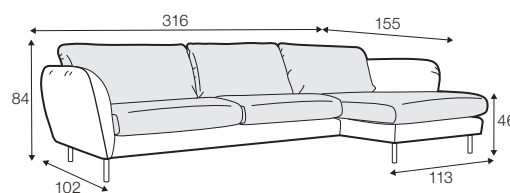

set 2 right / or left  
3 seater left / or right + chaiselongue wide right / or left

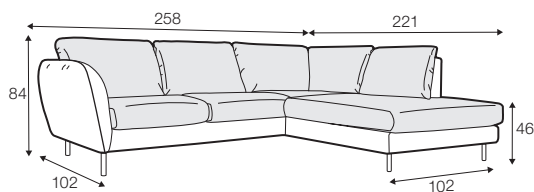

set 3 right / or left  
2 seater left / or right + divan right / or left

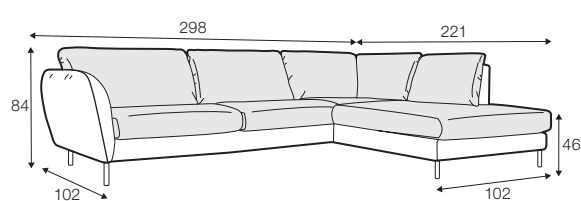

set 4 right / or left  
3 seater left / or right + divan right / or left

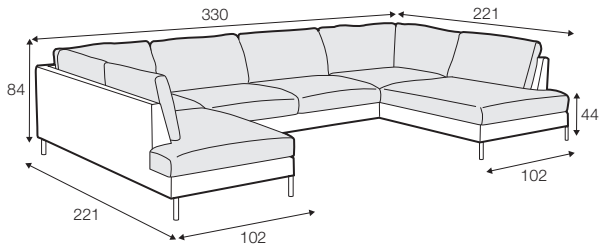

**set 6**  
divan left / or right + 2 seater without armrests + divan right / or left

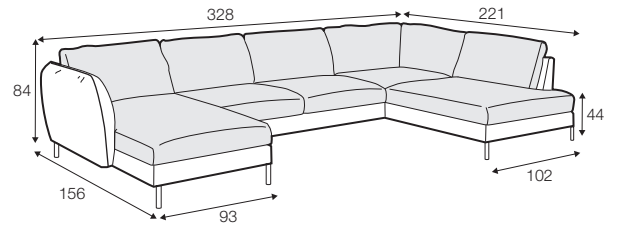

**set 7**  
chaiselongue left / or right + 2 seater without armrests + divan right / or left

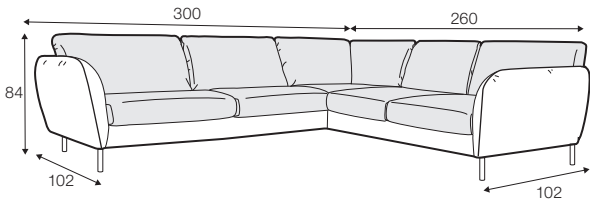

**set 8**  
3 seater left / or right + corner 90° no1 + 2 seater right / or left

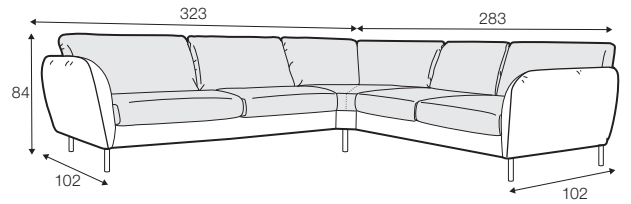

**set 9**  
3 seater left / or right + corner 90° no2 + 2 seater right / or left

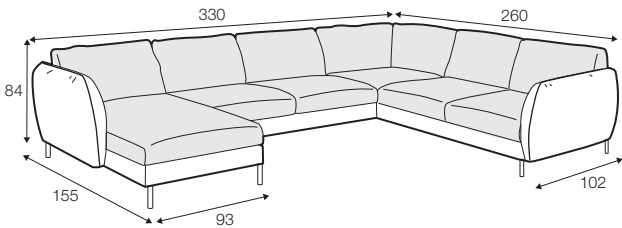

**set 10**  
chaiselongue left / or right + 2 seater without armrests + corner 90° no1 + 2 seater right / or left

## modular system

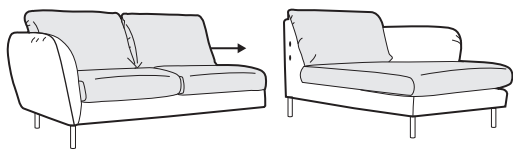

## elements of modular system

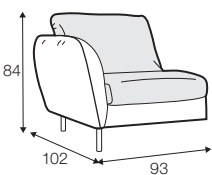

armchair left / or right

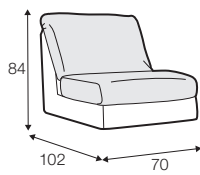

armchair without armrests

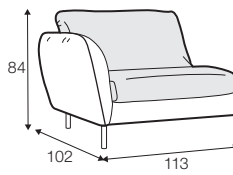

armchair wide left / or right

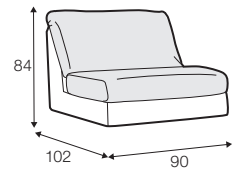

armchair wide without armrests

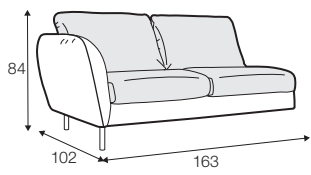

2 seater left / or right

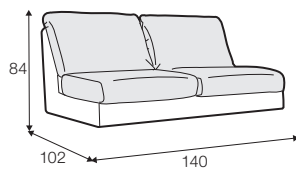

2 seater without armrests

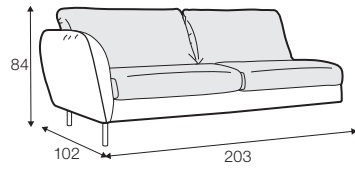

3 seater left / or right

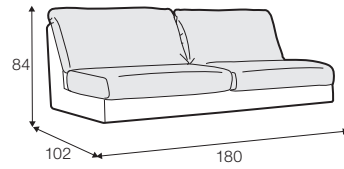

3 seater without armrests

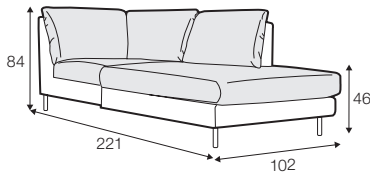

divan right / or left

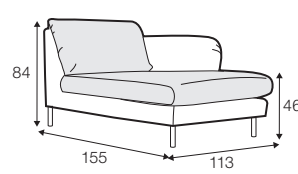

chaiselongue wide  
right / or left

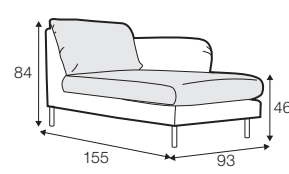

chaiselongue  
right / or left

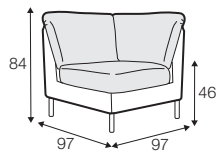

corner 90° no1

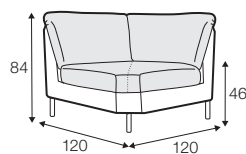

corner 90° no2

### extra dimensions

---

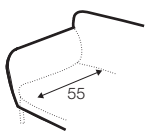

depth of seat

### accessories

---

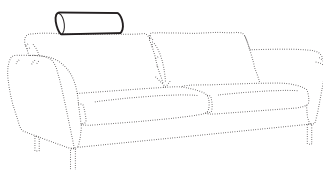

headrest L-62

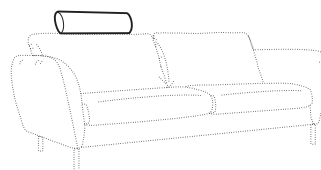
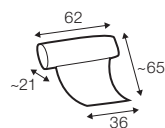

headrest L-77

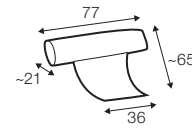

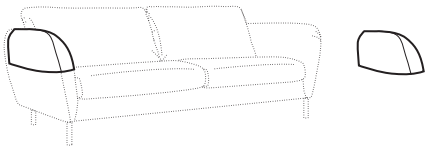

armrest protection

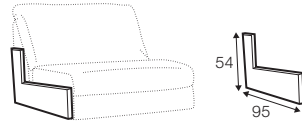

endpart

## legs

---

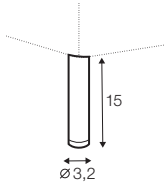

no. 195  
metal chrome,  
painted black

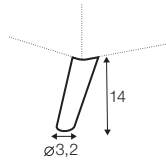

no. 141A  
wood

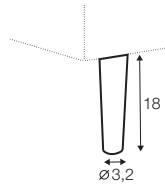

no. 141B  
wood

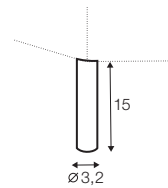

no. 196  
wood

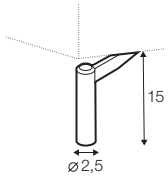

no. 145A  
metal chrome,  
painted black

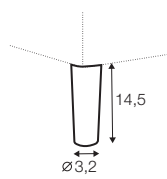

no. 153  
wood

## profile

---

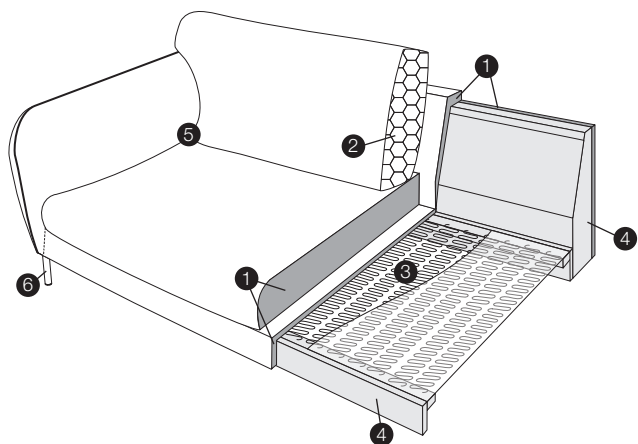

### standard

1. polyurethane foam/high resilient polyurethane foam
2. silicone balls
3. springs
4. solid wood and wood based elements
5. fabric
6. solid wood or metal legs

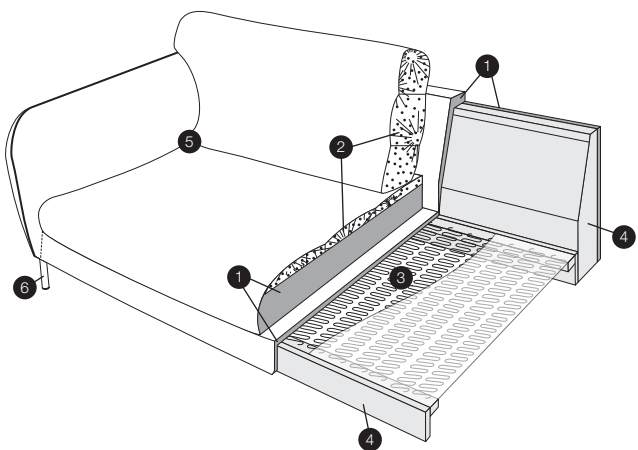

### lux

1. polyurethane foam/high resilient polyurethane foam
2. cushion chamber with mix of feather and silicone balls
3. springs
4. solid wood and wood based elements
5. fabric
6. solid wood or metal legs