

Bonnie

SITS



Bonnie

I. Archer

designed by: Ian Archer



UPHOLSTERY



fabric

COMFORTS



STD standard



LUX lux

COVERS



FC fixed

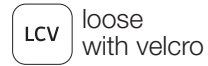

LCV loose with velcro

SPECIAL

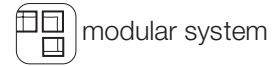

modular system

Footstool with venner top available only in fix cover.

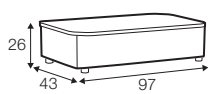

footstool 97x43
with venner top

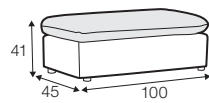

footstool 100x45

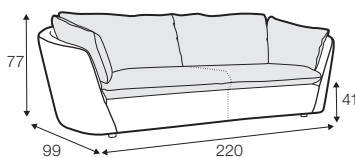

2 seater

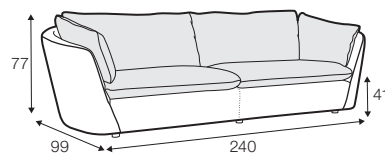

3 seater

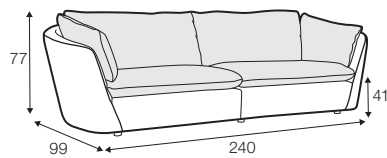

3 seater divided

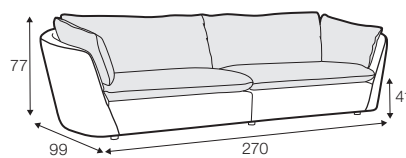

3XL seater divided

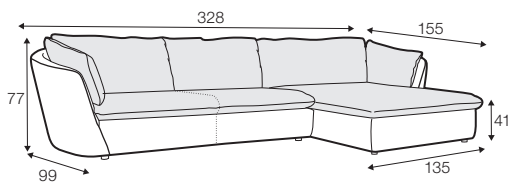

set 1 right / or left
2 seater left / or right + chaiselongue right / or left

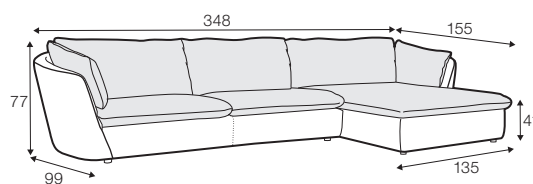

set 2 right / or left
3 seater left / or right + chaiselongue right / or left

modular system

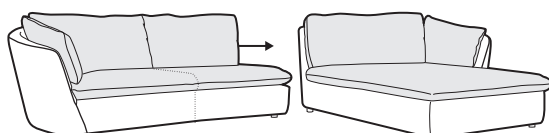

elements of modular system

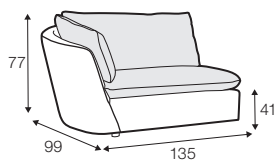

element 135 left / or right

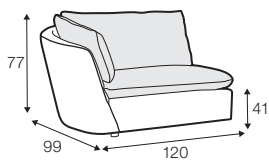

element 120 left / or right

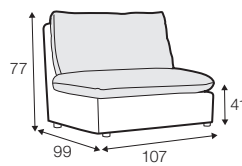

element 107 without armrests

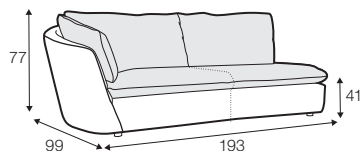

2 seater left / or right

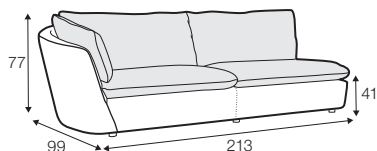

3 seater left / or right

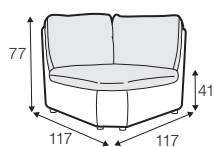

corner 90°

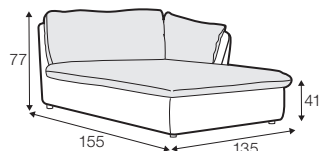

chaiselongue right / or left

extra dimensions

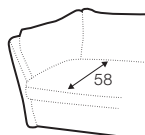

depth of seat

legs

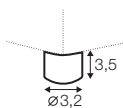

no. 173
wood

available materials for top



veneer: oak



veneer: white



veneer: black

profile

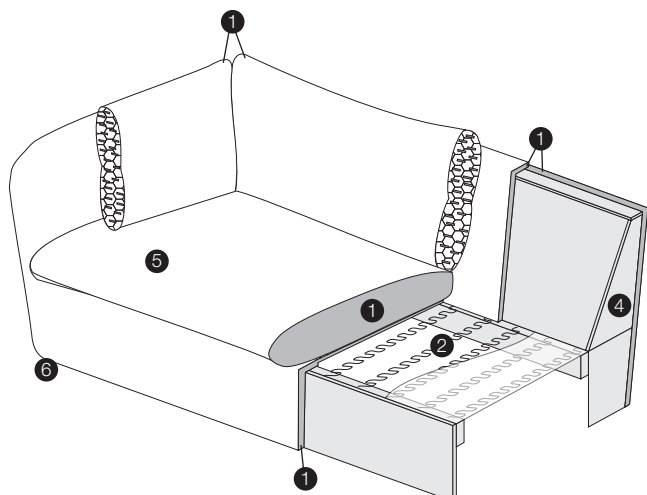

standard

1. polyurethane foam/ high resilient polyurethane foam
2. springs
3. cushion chamber with foam flakes and silicone balls
4. solid wood and wood based elements
5. fabric
6. soild wood legs

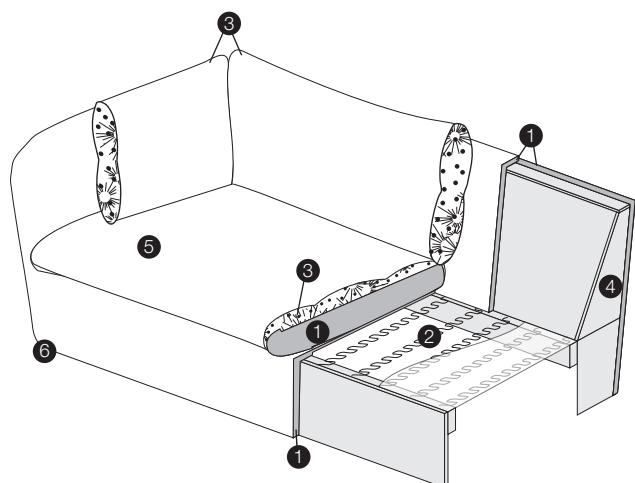

lux

1. polyurethane foam/ high resilient polyurethane foam
2. springs
3. cushion chamber with mix of feather and silicone balls
4. solid wood and wood based elements
5. fabric
6. soild wood legs