

Clyde

SITS



Clyde

J. Archer

designed by: Ian Archer



UPHOLSTERY

COMFORTS

COVERS



fabric



CLS classic



FC fixed

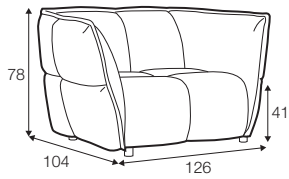

armchair

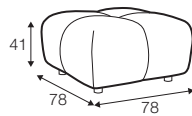

footstool 78x78

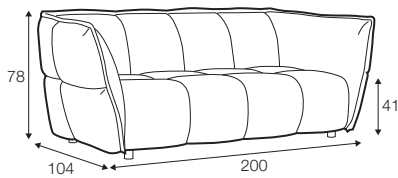

2 seater

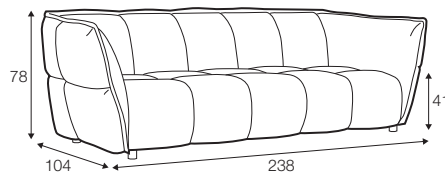

3 seater

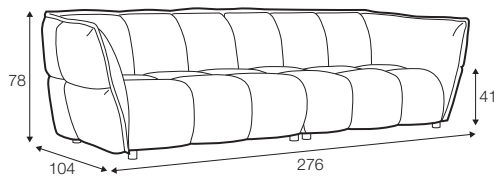

4 seater divided

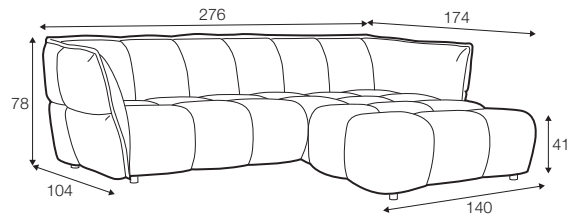

set 1 right / or left

element 138 left / or right + chaiselongue right / or left

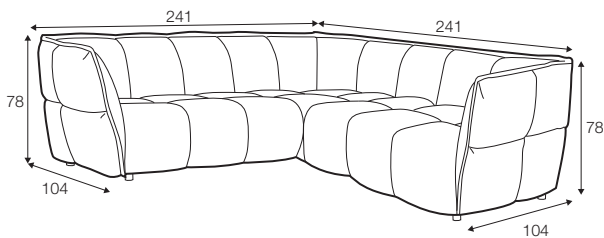

set 2

element 138 left / or right + corner 90°
+ element 138 right / or left

extra dimensions

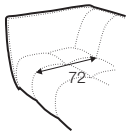

depth of seat

legs

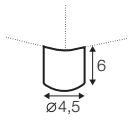

no. 36A
plastic

profile

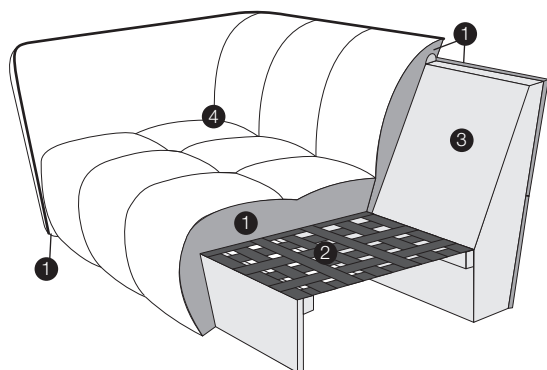

classic

1. polyurethane foam/high resilient polyurethane foam
2. upholstery belts
3. solid wood and wood based elements
4. fabric
5. plastic legs