

# Impulse

SITS



# Impulse

## UPHOLSTERY



## COMFORTS



## COVERS

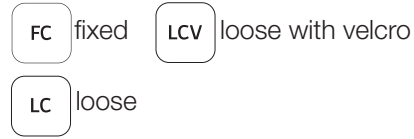

## SPECIAL



Drawing show combinations with armrest I. Combinantons with other armrest are properly longer or shorter in width.

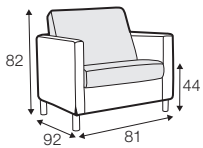

armchair

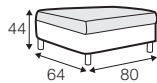

footstool 80x64

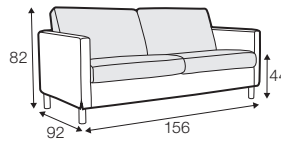

2 seater

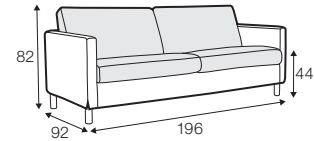

2,5 seater

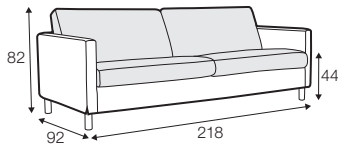

3 seater

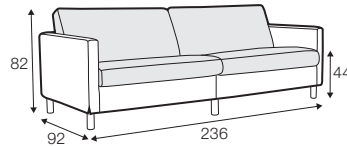

4 seater divided

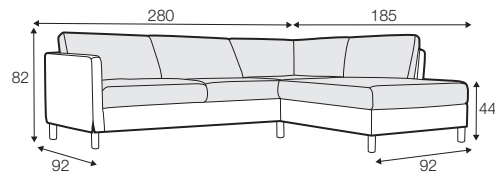

set 4 right / or left  
2,5 seater left / or right + divan right / or left

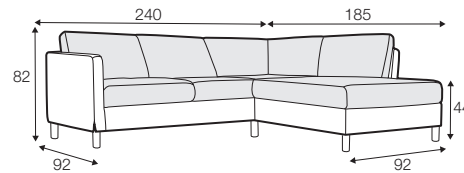

set 5 right / or left  
2 seater left / or right + divan right / or left

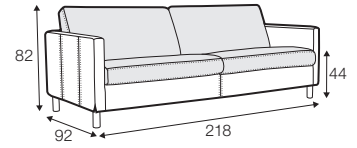

example of leather cover  
3 seater

## modular system

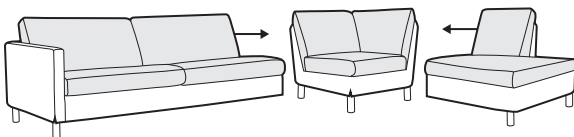

## elements of the modular system

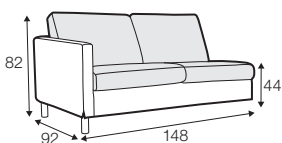

2 seater left / or right

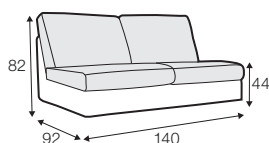

2 seater  
without armrests

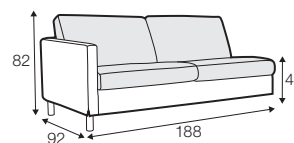

2,5 seater left / or right

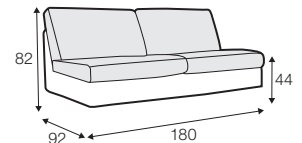

2,5 seater  
without armrests

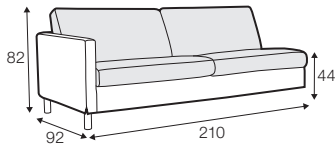

3 seater left / or right

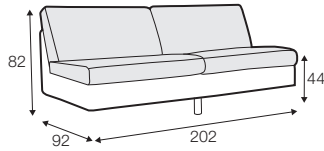

3 seater  
without armrests

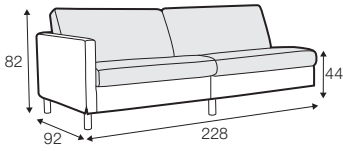

4 seater divided left / or right

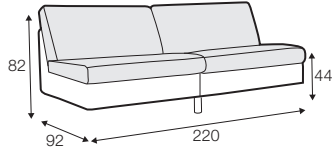

4 seater divided  
without armrests

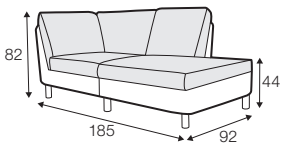

divan right / or left

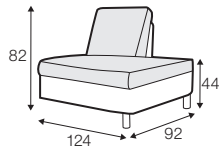

bench right / or left

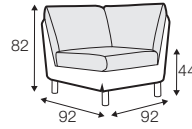

corner 90°

## extra dimensions

---

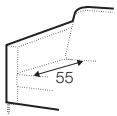

depth of seat

## accessories

---

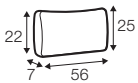

cushion

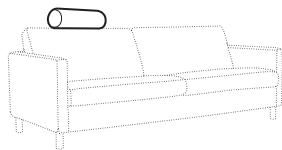

headrest with roll L-60

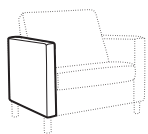
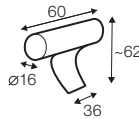

armrest I

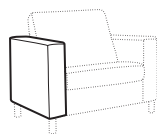
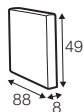

armrest II

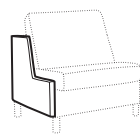
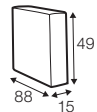

endpart left / or right

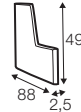

## legs

---

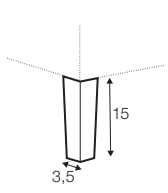

no. 109  
wood

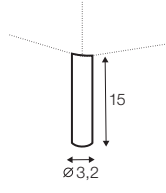

no. 195  
metal chrome,  
painted black

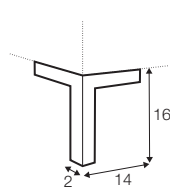

no. 47  
metal chrome,  
painted black

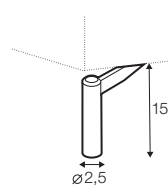

no. 145A  
metal chrome,  
painted black

### All legs can be fixed to both armrests:

---

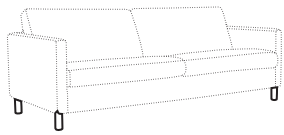

under armrest

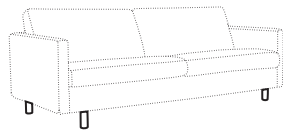

under frame

## profile

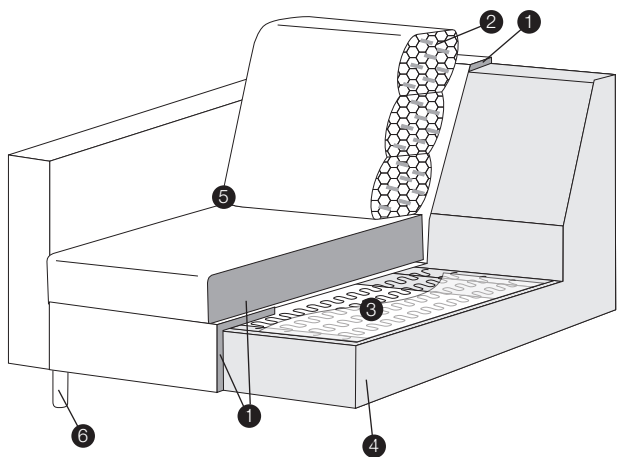

### standard

1. polyurethane foam/ high resilient polyurethane foam
2. foam flakes with silicone balls
3. springs
4. solid wood and wood based elements
5. fabric or leather
6. FSC® certified solid wood or metal legs

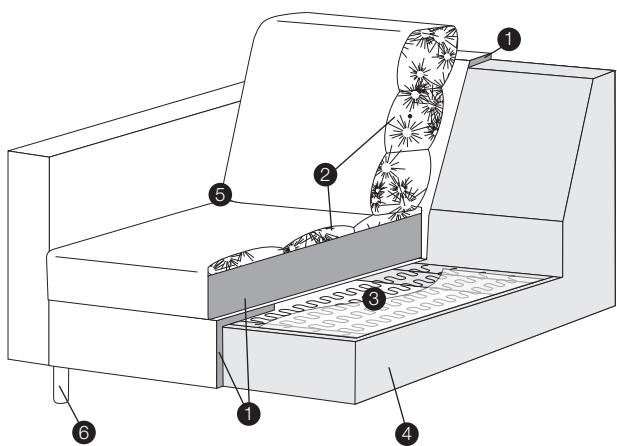

### lux

1. polyurethane foam/ high resilient polyurethane foam
2. cushion chamber with mix of feather and silicone balls
3. springs
4. solid wood and wood based elements
5. fabric or leather
6. solid wood or metal legs

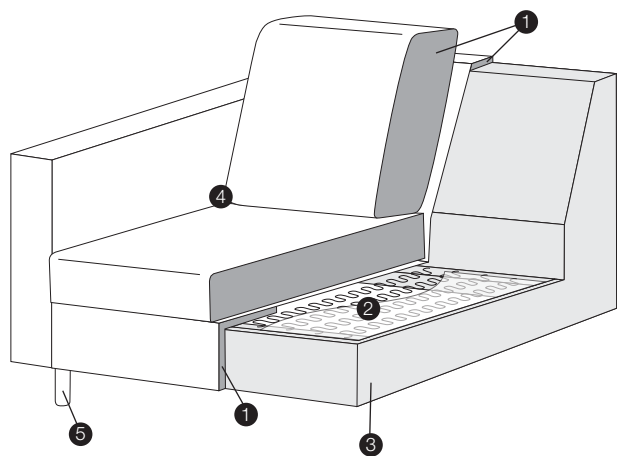

### plus

1. polyurethane foam/ high resilient polyurethane foam
2. springs
3. solid wood and wood based elements
4. fabric or leather
5. solid wood or metal legs