

Emma

SITS



Emma

J. Archer

designed by: Ian Archer



UPHOLSTERY



fabric

COMFORTS



standard



lux

COVERS



fixed



loose with velcro

SPECIAL



modular system

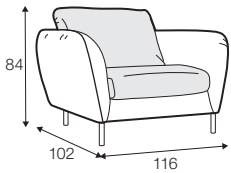

armchair

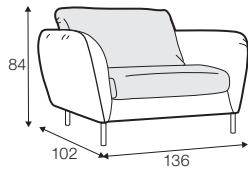

armchair wide

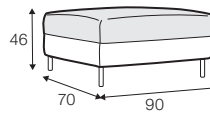

footstool 90x70

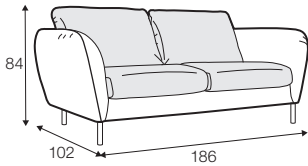

2 seater

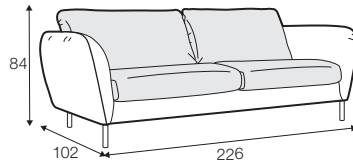

3 seater

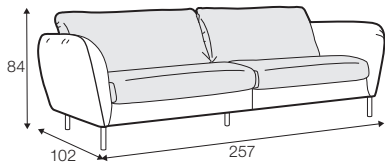

3XL seater divided

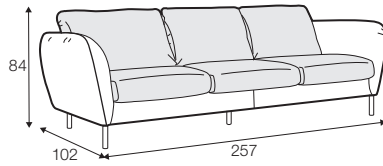

3XL seater divided
with 3 cushions

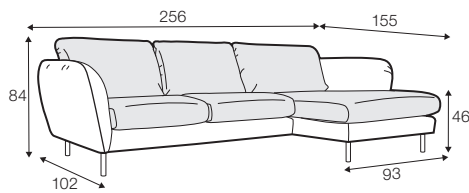

set 1 right / or left
2 seater left / or right + chaiselongue right / or left

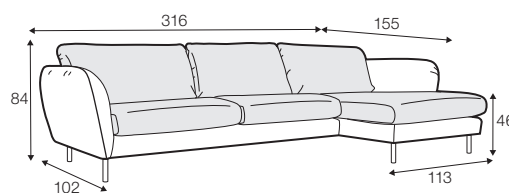

set 2 right / or left
3 seater left / or right + chaiselongue wide right / or left

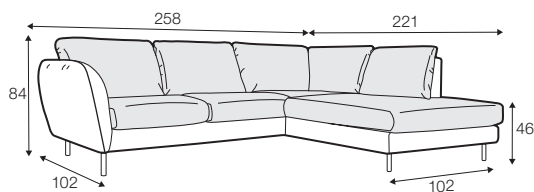

set 3 right / or left
2 seater left / or right + divan right / or left

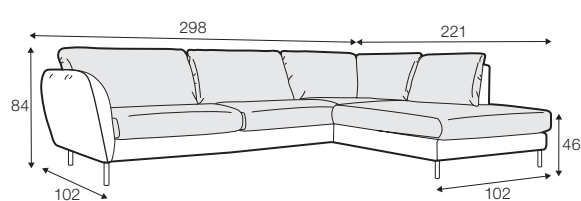

set 4 right / or left
3 seater left / or right + divan right / or left

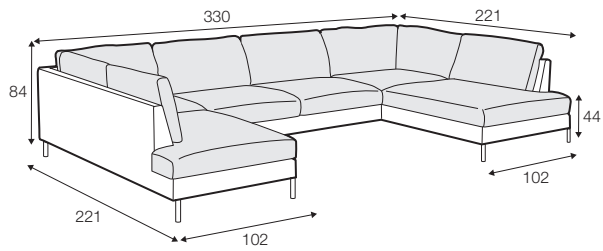

set 6
divan left / or right + 2 seater without armrests + divan right / or left

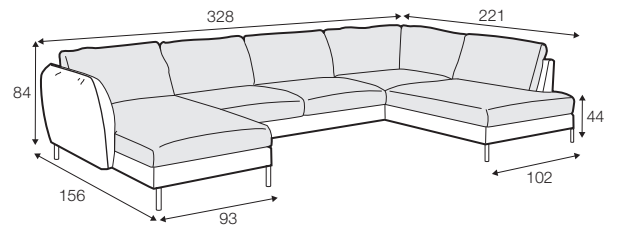

set 7
chaiselongue left / or right + 2 seater without armrests + divan right / or left

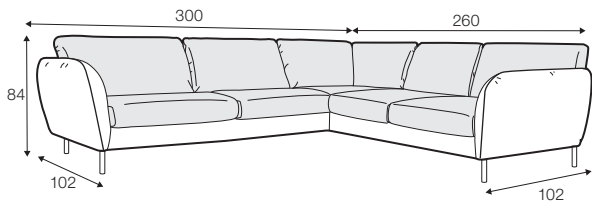

set 8
3 seater left / or right + corner 90° no1 + 2 seater right / or left

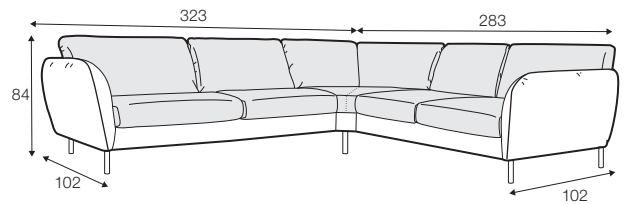

set 9
3 seater left / or right + corner 90° no2 + 2 seater right / or left

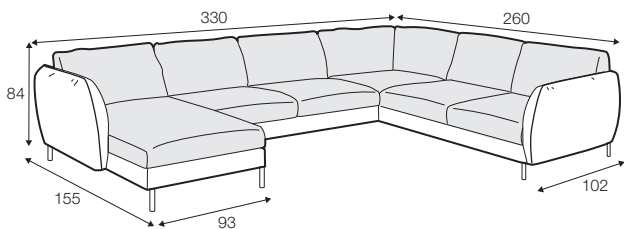

set 10
chaiselongue left / or right + 2 seater without armrests + corner 90° no1 + 2 seater right / or left

modular system

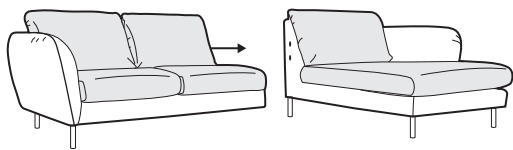

elements of modular system

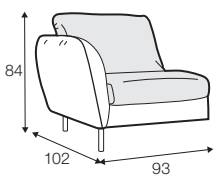

armchair left / or right

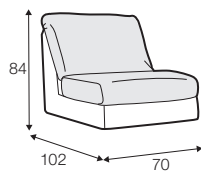

armchair without armrests

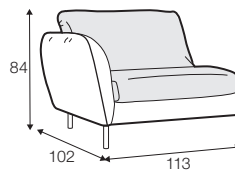

armchair wide left / or right

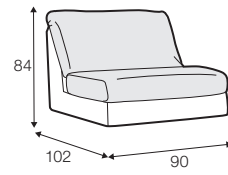

armchair wide without armrests

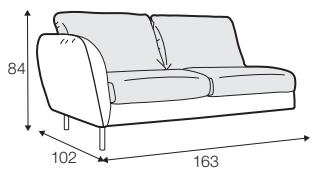

2 seater left / or right

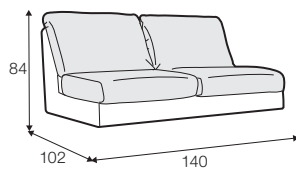

2 seater without armrests

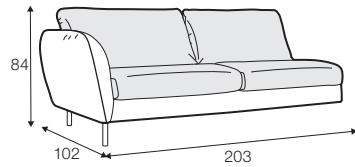

3 seater left / or right

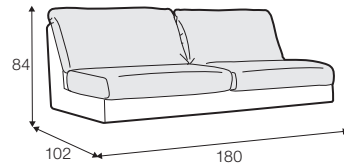

3 seater without armrests

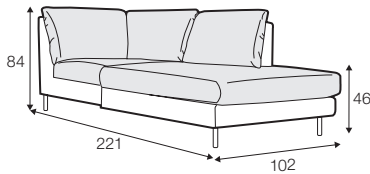

divan right / or left

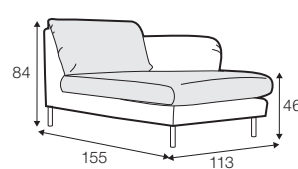

chaiselongue wide
right / or left

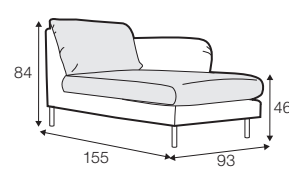

chaiselongue
right / or left

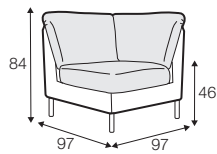

corner 90° no1

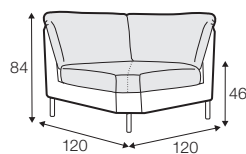

corner 90° no2

extra dimensions

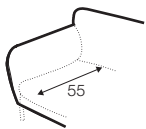

depth of seat

accessories

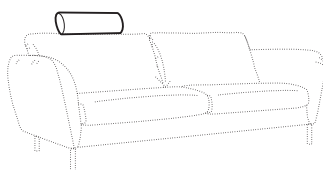

headrest L-62

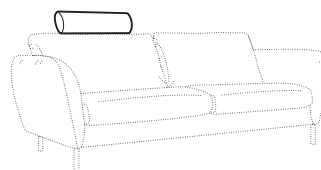
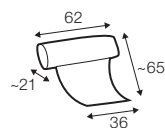

headrest L-77

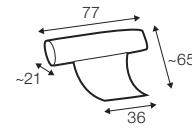

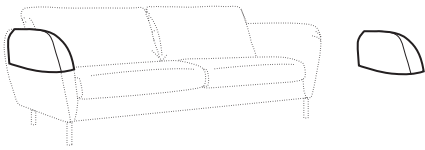

armrest protection

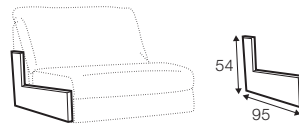

endpart

legs

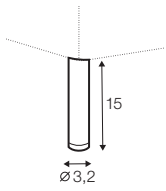

no. 195
metal chrome,
painted black

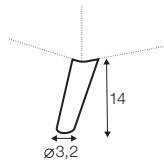

no. 141A
wood

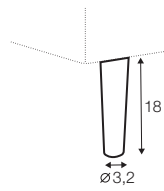

no. 141B
wood

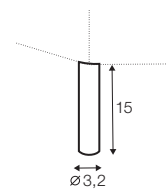

no. 196
wood

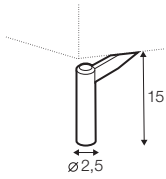

no. 145A
metal chrome,
painted black

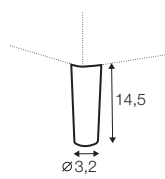

no. 153
wood

profile

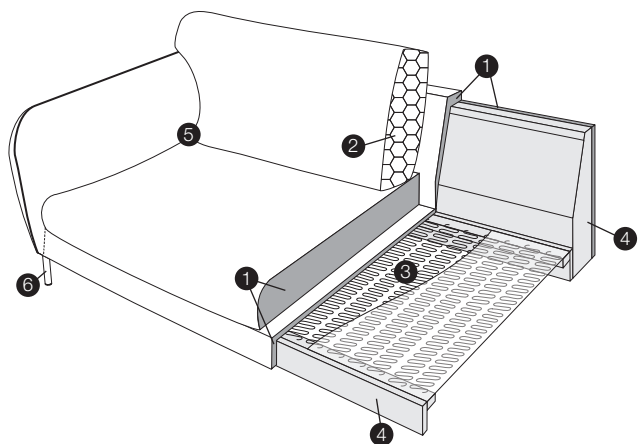

standard

1. polyurethane foam/high resilient polyurethane foam
2. silicone balls
3. springs
4. solid wood and wood based elements
5. fabric
6. solid wood or metal legs

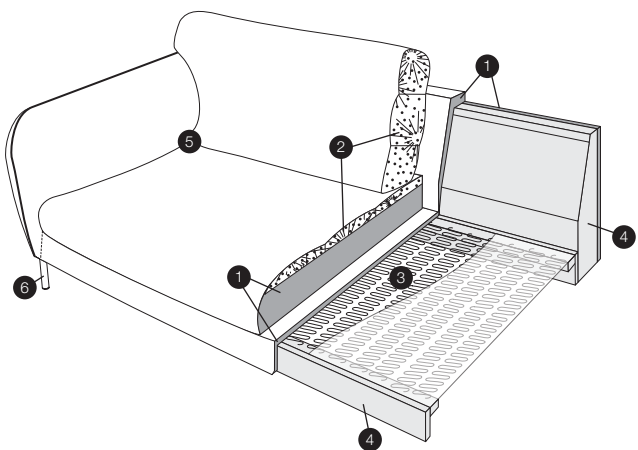

lux

1. polyurethane foam/high resilient polyurethane foam
2. cushion chamber with mix of feather and silicone balls
3. springs
4. solid wood and wood based elements
5. fabric
6. solid wood or metal legs